



CAZA

FOR CONSTRUCTION INDUSTRIES

 cazajo.com



CAZA
FOR CONSTRUCTION INDUSTRIES

COMPOSITE COVERS ADVANTAGES

OUR COMPANY

CAZA is located in the heart of Jordan, Amman.

Having up-to-date machines and cutting edge technologies, this put us in a unique position of being the leader producer in the area and a competitive player in the major world markets.

Our Products:

- SMC Manhole Covers
- BMC Manhole Covers
- Rain-water Grates
- Recessed Manhole Covers (Tiles and Lawn well)
- Valve Box
- Drainage Channel
- Manhole Chambers

Our Expertise:

Years of experience have contributed towards our ranking as a major influence in the industrial world. At CAZA we provide products, solutions, services and the necessary technical back-up to our clients. We are a well formed team of specialized engineers and professionals who have expertise in every critical area of production and development.

Our Commitment:

Every time we open our doors we continue a commitment that has been growing in us; a happier customer and a satisfied client. We believe that we are not number one but you are.

SMC and BMC:

SMC is the short form of Sheet Moulding Compound.
BMC is the short form of Bulk Moulding Compound.

SMC and BMC materials are designed to success, as a fiber-reinforced composite material, consisting of thermosetting resin, glass fibre reinforcement and additional ingredients to give the covers the qualities and characteristics required.

Comparing with the traditional ductile cast iron, our manhole covers own better performance at testing load rating. They are able to meet and exceed loading rating according to EN 124. Being non recyclable, composites manhole covers will solve the theft and stealing problems as they have zero cycle value.

Other significant advantages are also remarkable; light-weighted, durable service life, anti-corrosion, anti-slip, UV-proof, water tight and free design.

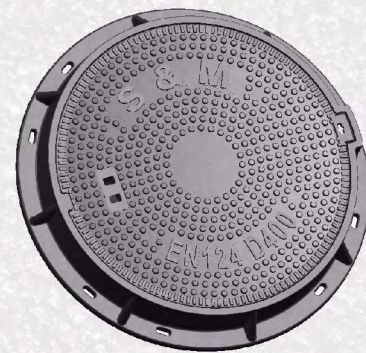

1. High load rating and strength

- Similar hard properties as cast iron, while having an overwhelming advantage on stretch recovery and bend resistance.
- Designed to meet and exceed A15/ B125 / C250 / D400 / E600 / F900 loading rating, according to EN124
- Less noise and lower Vibration Transmissions .
- Certificated with CE, EN124, SGS, Eurofins, BV and ISO9001.

2. Against theft and safety options

- Compared with cast iron manhole covers, composite covers have zero theft value and not attractive to thieves.
- Surface anti-slip thread guarantees safe road conditions even in extreme weather.
- Locks are available as an option molded into the cover to improve security rate.
- Non-electrical and heat conduction and UV resistant.

3. Light weighted

- Compared with cast iron manhole covers, composit covers are 30% lighter.
- Light weight allows ease of handling, more loading per vehicle, easier transportation and economical savings.
- Allows a safer working condition, which a single worker is enough for a complete installation without risk of injury.
- Ease of moving, and maintenance.

4. Durable service life

- More than 30 years theoretical service life at usual road condition.
- Anti-corrosion, waterproof, dust and pets tight, well sealed prevent poisonous gas leaking out.
- Without displacement, freely radio signal passing.
- Higher and lower temperature tolerance with the range - 40 °C up to 200 °C .

5. Free design

- Composite material itself allows for Innovative design features.
- Client logo and designs are available as an option.
- Better resolution ratio of surface design than cast iron or of other materials.

6. Carbon footprint saving and environmental care

- Lower embedded energy carbon emissions during manufacturing process than cast iron covers.
- New materials, manufacturing technologies and lean production ideas.



EN124 Standards:

1. Classification

The procedure for installing manhole covers and gully tops depends on the installation location, the corresponding traffic loads, and the planned surface layer. Installation locations are assigned to classes A15 through F900 in EN 124. The manhole structure must be suitable for the traffic load. The planner is responsible for choosing the correct load class.



2. Place of installation

The appropriate class of manhole covers or gully gratings to be used depends upon the place of installation. The various places of installation have been divided into groups numbered 1 to 6, as listed below. The figure below shows the location to some of these groups in a highway environment. A guide as to which class of manhole covers or gully gratings should be used is shown in parentheses for each group. The selection of the appropriate class is the responsibility of the designer. Where there is any doubt, the stronger class should be selected.

LIGHT DUTY TO MEDIUM DUTY

HEAVY DUTY TO EXTRA HEAVY DUTY



Group 1 (min. class A15).
- Areas which can only be used by pedestrians and pedal cyclists.



Group 4 (min. class D400).
- Carriageways of roads (including pedestrian streets), hard shoulders and parking areas, for all types of road vehicles.



Group 2 (min. class B125).
- Footways, pedestrian areas and comparable areas, car parks for car parking decks.



Group 5 (min. class E600).
- Areas imposing High wheel loads, e.g. docks, aircraft pavement.



Group 3 (min. class C250).
- For gully tops installed in the area of kerbside channels of roads which when measured from the kerb edge, extend a maximum of 0.5m into the carriageway at a maximum of 0.2m into the footway.



Group 6 (min. class F900).
- Areas imposing particularly high wheel loads, e.g. aircraft pavements.





INSTALLATION

1. Check the whole depth and manhole opening diameter that the frame is to be fitted on, ensuring the latter manhole cover to be installed is on the same flat with Road.

- If necessary, insert a formwork around the manhole on which the cover is to be fitted.
- Make sure that the frame does not lay on the formwork when in its final position.

2. Check the condition of the manhole opening and remove any dust from the support and manhole opening.

3. Lay a coat of sealing products around the top of the manhole.

The minimum recommended thickness for the coat under the frame, once installed and levelled, is:

- 40 mm in the case of quick setting "micro-concrete" type sealing products,
- 80 mm in the case of a 350 CPA concrete sealing.

4. Lay the frame directly on the sealing product.

5. Adjust the frame to the same level as the wearing course. The adjustment should be carried out by the exerting downward pressure on the frame with wooden hammer to ensure that the sealing product spread evenly under the surface.

The requirement of the thickness under the frame, Please refer to POINT 3.

6. Clean the edge of clear opening and put on the cover.

7. Fill with sealing product and use a float to level off the product.

- If the road is asphalt, leaving 30 to 50 mm for the latter laying of the asphalt course.

8. After the concrete final set, clean the installation area and maintain with water no less than 7 days .

NOTE:

- In case of some HINGED manhole cover, leave a clearance space under the hinge box and lock part.
- Any manhole cover quality problems caused by UNQUALIFIED INSTALLATION will not be suitable to our product WARRANTY TERMS.
- We strongly recommend installing the product according to our INSTRUCTIONS.
- Tiny installation improvement is recommended according to different installing condition.

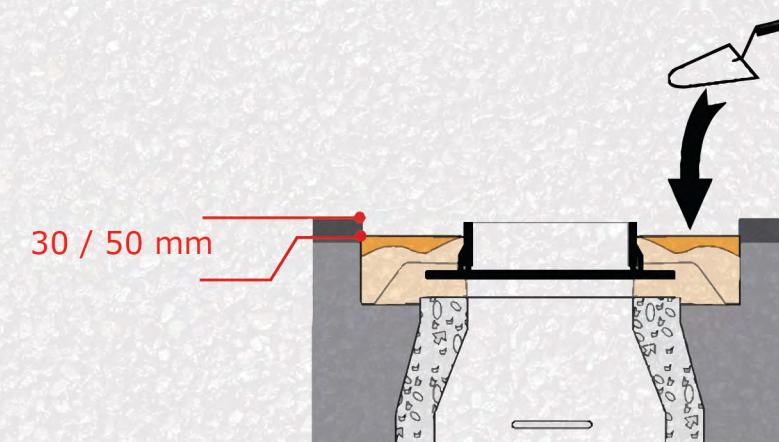
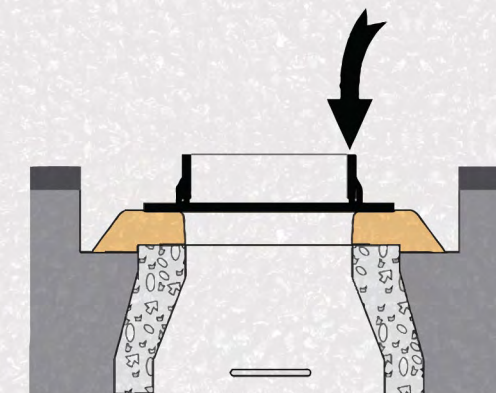
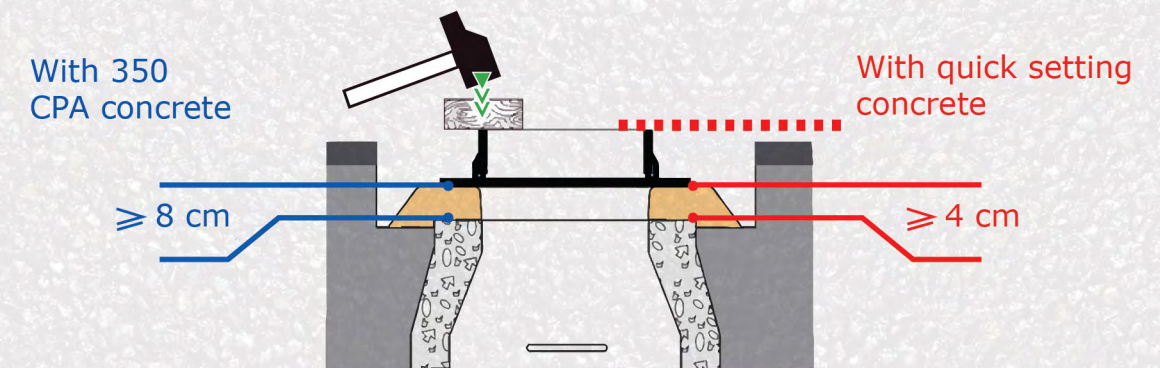



CAZA
FOR CONSTRUCTION INDUSTRIES

OUR PRODUCTS

1) SMC Manhole Covers:

SMC Manhole covers are state of the art in composite and infrastructure departments. The superior mechanical properties made SMC manhole cover the first choice in highways, expressways, airports, factories, warehouses etc, widely replacing cast iron and plastic manhole covers.

Below are the main items available in this category. Please note that different required classes and dimensions are available. Moreover, different kinds of anti slip patterns and customized designs, logos and colours are fully supported.

Round Manhole Covers

Product Code	Opening	Frame	Class	Tons
MC-0840-D	840	1065	D400	40
MC-0840-C	840	1065	C250	25
MC-0750-D	750	910	D400	40
MC-0750-C	750	910	C250	25
MC-0650-D	650	800	D400	40
MC-0650-C	650	800	C250	25
MC-0600-C	600	700	C250	25
MC-0600-B	600	700	B125	12.5

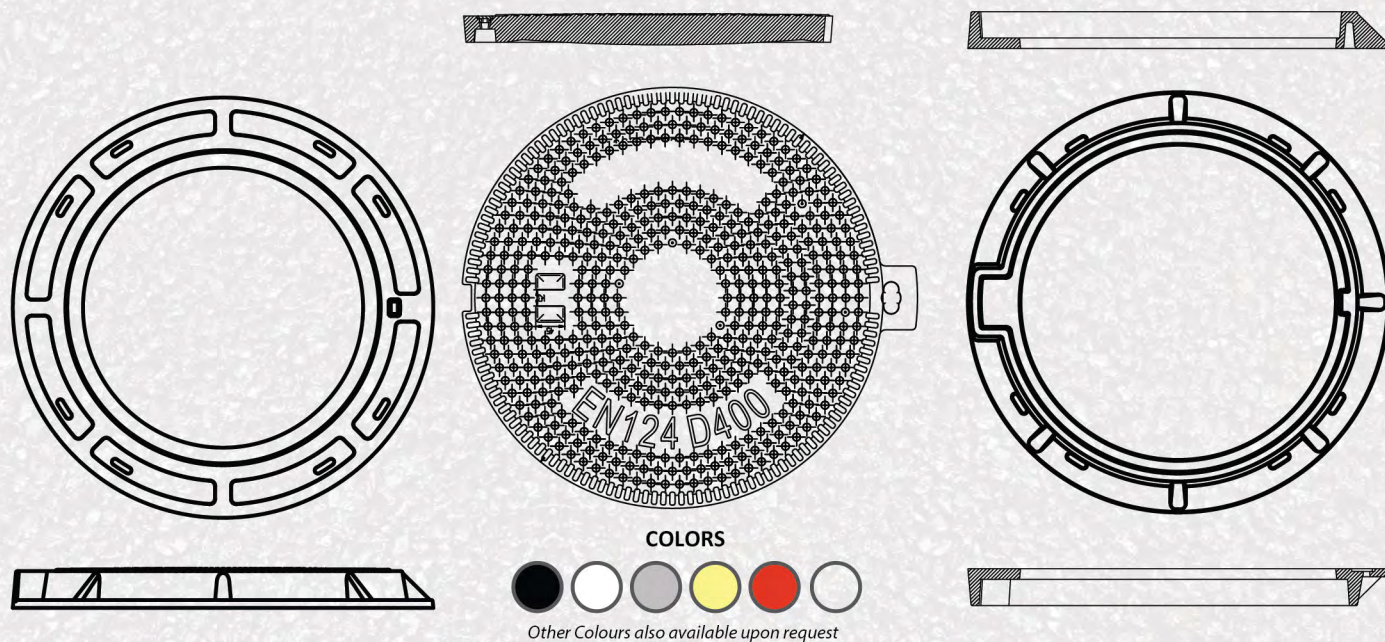

Square Manhole Covers

Product Code	Opening	Frame	Class	Tons
MC-1700-C	700	800	C250	25
MC-1700-B	700	800	B125	12.5
MC-1600-C	600	700	C250	25
MC-1600-B	600	700	B125	12.5
MC-1500-C	500	600	C250	25
MC-1500-B	500	600	B125	12.5
MC-1400-C	400	500	C250	25
MC-1400-B	400	500	B125	12.5
MC-1300-C	300	400	C250	25
MC-1300-B	300	400	B125	12.5

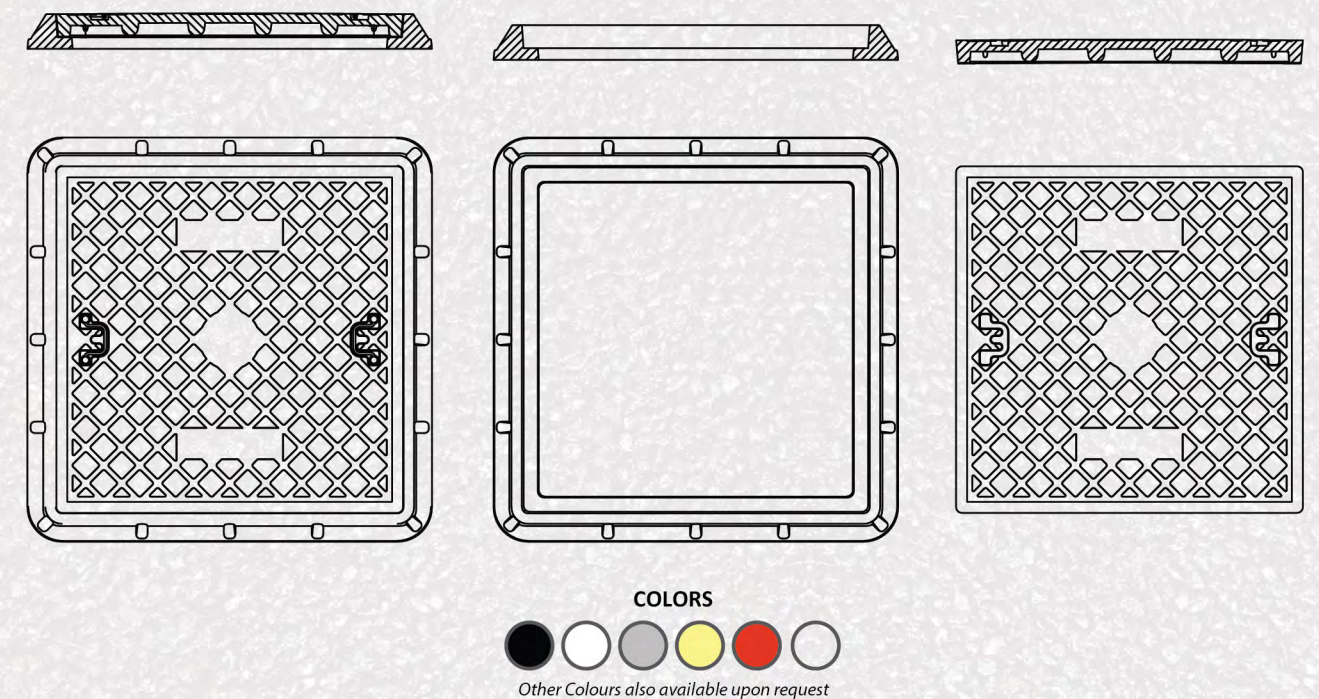



CAZA
FOR CONSTRUCTION INDUSTRIES

OUR PRODUCTS

2) BMC Manhole Covers:

BMC Manhole covers are the most demanded manhole covers in the infrastructure market, the composite material combined with the metal framework gives the cover unique properties, allowing it be used in car parking, gardens, garages, pavements, real estates, sidewalks, buildings etc.

Below are the main items available in this category. Please note that different required classes and dimensions are available. Moreover, different kinds of anti slip patterns and customized designs, logos and colours are fully supported.

Round Manhole Covers

Product Code	Opening	Frame	Tons	Metal Framework
MC-0600-8	600	700	8	Yes
MC-0600-5	600	700	5	Yes
MC-0500-8	500	600	8	Yes
MC-0500-5	500	600	5	Yes

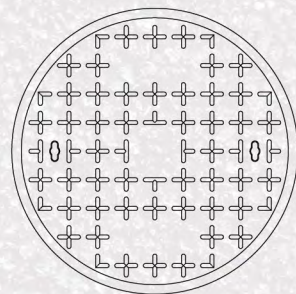
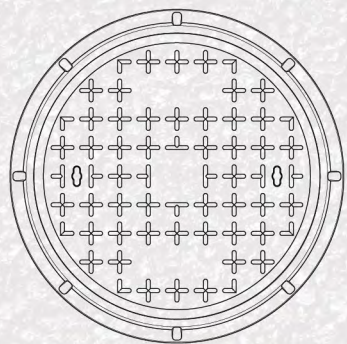
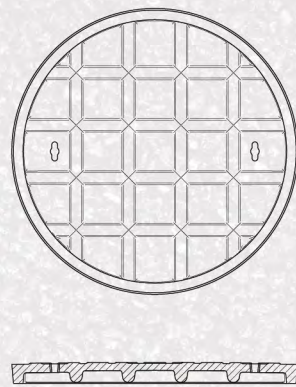
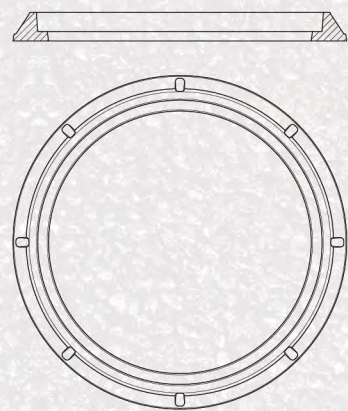
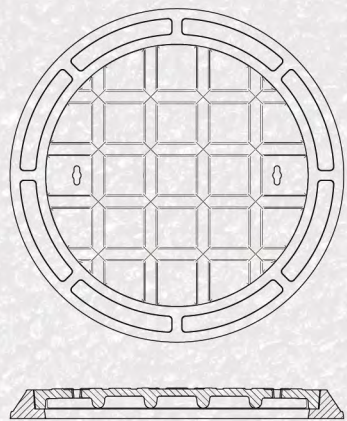

Other Colours also available upon request

Square Manhole Covers

Product Code	Opening	Frame	Tons	Metal Framework
MC-1700-8	700	800	8	Yes
MC-1700-5	700	800	5	Yes
MC-1600-8	600	700	8	Yes
MC-1600-5	600	700	5	Yes
MC-1500-8	500	600	8	Yes
MC-1500-5	500	600	5	Yes
MC-1400-8	400	500	8	Yes
MC-1400-5	400	500	5	Yes
MC-1300-8	300	400	8	Yes
MC-1300-5	300	400	5	Yes

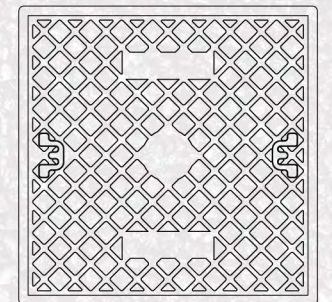
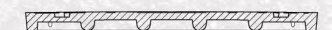
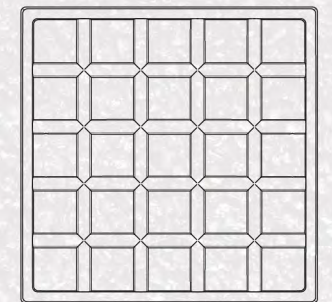
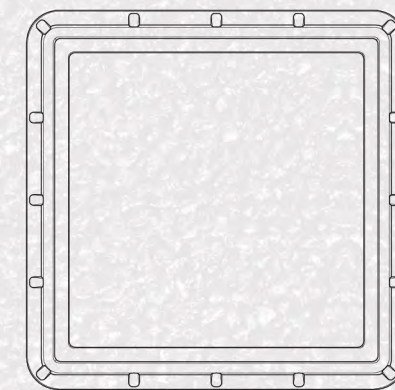
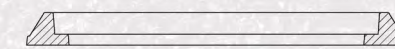
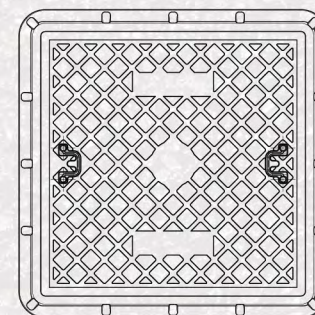
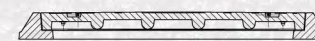
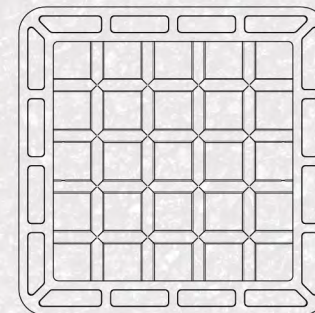

Other Colours also available upon request



3) Rain Water Grates:

After researching and studying the market, we found a need of having a drainage solution offering the most durable Trench and channel grates for a variety of applications. In order to fill this gap, we have engineered a water grate with a well designed slots to avoid small objects falling through.



Product Code	Opening	Frame	Tons	Material	Metal Framework	Class
WG-5030C	500*300	600*400	25	SMC	No	C250
WG-5030B	500*300	600*400	12.5	SMC	No	B125
WG-50308	500*300	600*400	8	BMC	Yes	
WG-50305	500*300	600*400	5	BMC	Yes	

4) SMC Recessed Manhole covers

Recessed Manhole Covers offer a discreet manhole option as they can be filled with paving, block paviors or gravel. It is an aesthetical pleasing solution demanded by the infrastructure accessories market.

Product Code	Opening	Frame	Shape	Class	Tons
RC-1600-A	600	700	Square	A15	1.5
RC-1500-A	500	600	Square	A15	1.5
RC-0600-A	600	700	Round	A15	1.5

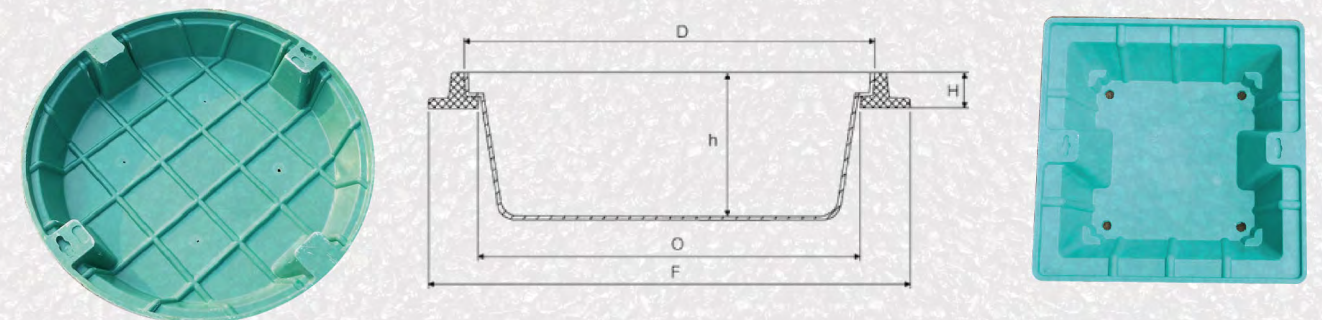
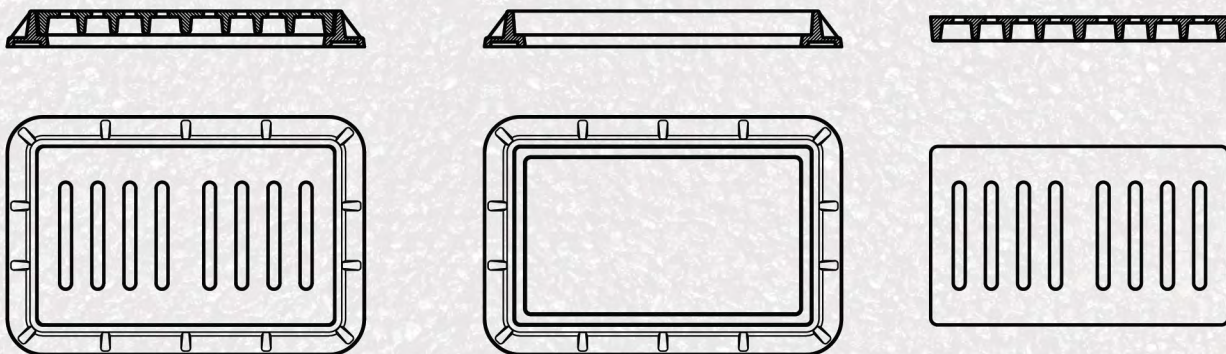



CAZA
FOR CONSTRUCTION INDUSTRIES

OUR PRODUCTS

5) SMC Valve Box

When it comes to valve system installation and design, valve boxes play an important role as it provides damage protection from children, animals, vandalism, etc. Moreover, it provides easy access for maintenance and hide unsightly irrigation components from sight. Our SMC Valve boxes are available in multiple sizes and shapes to provide the right fit for any application.



6) Channel Drain

This is the generic term for linear systems that incorporate a channel together with an inlet detail that is embedded in the constructed surface.

The channel body can be manufactured from Polymer Concrete, Plastic or Steel.

The embedded inlet detail can vary considerably from cast iron, steel or polymer composite gratings through to an inlet detail or 'slot' that can barely be seen.

Channel drains are typically structural formers that are integral to the performance of the system but may or may not be load bearing without the required surround detail.

Our channel systems are used for external and internal applications, from Airports to Kitchens.

Product Code	Dimension	Shape	Class	Tons
VB-1-6A	6"	Square	A15	1.5
VB-1-6B	6"	Square	B125	12.5
VB-1-8A	8"	Square	A15	1.5
VB-1-8B	8"	Square	B125	12.5
VB-1-10A	10"	Square	A15	1.5
VB-1-10B	10"	Square	B125	12.5
VB-0-6A	6"	Round	A15	1.5
VB-0-6B	6"	Round	B125	12.5
VB-0-8A	8"	Round	A15	1.5
VB-0-8B	8"	Round	B125	12.5
VB-0-10A	10"	Round	A15	1.5
VB-0-10B	10"	Round	B125	12.5

Product code	Opening	Frame	Class	Tons
CD-1010-A	10*10	15*15	A15	1.5
CD-1010-B	10*10	15*15	B125	12.5
CD-1010-C	10*10	15*15	C250	25
CD-1010-D	10*10	15*15	D400	40
CD-1515-A	15*15	20*20	A15	1.5
CD-1515-B	15*15	20*20	B125	12.5
CD-1515-C	15*15	20*20	C250	25
CD-1515-D	15*15	20*20	D400	40





CAZA
FOR CONSTRUCTION INDUSTRIES

OUR PRODUCTS

7) Manhole Chambers:

- Made of PP-B Plastic which have excellent chemical and corrosion resistance
- Push-fit connection by rubber ring
- Easy to install.
- Water tightness.
- Smooth internal surface, little friction for better flow.
- Easy to handle.
- Low weight.
- Riser shafts and extension rings to build up the required height easily.
- Heavy duty and durable.



Manhole Opening	52 cm
Manhole Height	30 cm
Riser Height	25 cm
inlets	2 x 160mm + 2 x 110mm
outlets	2 x 160mm

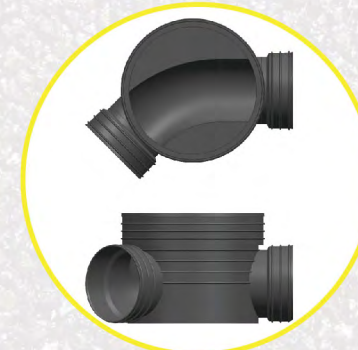

BEND



REDUCER SHAFT

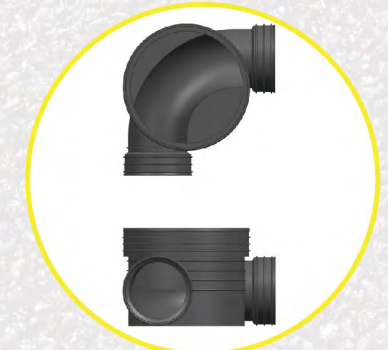

BEND 90



TEE



WYE BRANCHED



JUNCTION TEE



CROSS

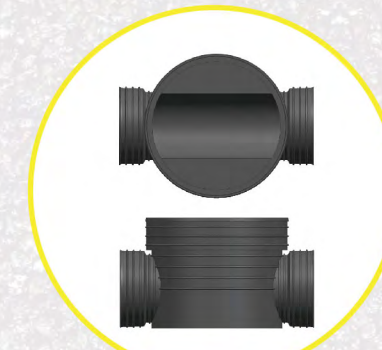

STRAIGHT

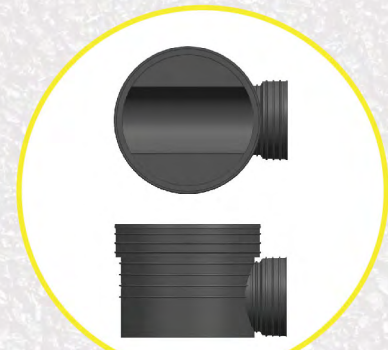

SINGLE

Manhole Opening	315mm	450mm	630mm	700mm	1000mm
Riser Height, Inlets and Outlets	As requested				



CAZA
FOR CONSTRUCTION INDUSTRIES

NOTES







CONCRETE VS PLASTIC MANHOLES



Concrete



Plastic

 Tightness	<p>It is difficult to guarantee the system tightness or to stop the waste water infiltrations to the soil due to high porosity and cracks.</p>	<p>The absence of porosity and cracks, guarantees the water tightness for life as it avoids the infiltrations through the manhole walls.</p>
 Resistance	<p>Waste water is composed of agents that attack and damage the concrete leading to corrosion.</p>	<p>Plastics are resistant to Acid, Salts and corrosive agents that are aggressive in behaviour.</p>
 Chemical Resistance	<p>No resistance guarantee to chemical products or leachates, due to concrete corrosion produced on the walls and manhole bottom.</p>	<p>The use of plastic manholes for the evacuation of industrial used water, chemical wastes and land fillings are strongly indicated.</p>
 Easy Installation.	<p>It needs heavy machinery for installation. A concrete manhole of 1 meter diameter and 2 meters height, weight around 2500 kg.</p>	<p>Quickness and simplicity in the installation, without the need of using heavy machinery. Thus, reducing installation costs.</p>
 Flexibility	<p>Any movement or vibrations of the soil can produce cracks in the body or in the rigid joints.</p>	<p>Plastic flexibility allows them to adapt to the soil and avoids breaking due to the seismic movements.</p>
 Maintenance	<p>It must be interfered more frequently as the rigidity of the concrete makes both solid and liquids dragged by the waste water become stagnant.</p>	<p>They do not need much maintenance, as the inside surface of plastic manholes are flat and smooth with slopes towards the exits to assure liquids flow.</p>



CAZA
FOR CONSTRUCTION INDUSTRIES

Tel : + (962) 6 487 20 14 / 5 - Fax : + (962) 6 488 40 05
 P.O.Box : 420303 Amman 11142 Jordan
 Email : info@cazajo.com
 www.cazajo.com





CAZA

FOR CONSTRUCTION INDUSTRIES

Tel : + (962) 6 487 20 14 /5

Fax : + (962) 6 488 40 05

P.O.Box : 420303 Amman 11142 Jordan

Email : info@cazajo.com

www.cazajo.com